

Product Description

RFMD's XD010-14S-D4F 15W power module is a robust 2-Stage Class A/AB amplifier module for use in GSM and EDGE RF applications. This module is optimized to minimize the EVM at typical operating levels. The power transistors are fabricated using RFMD's latest, high performance LDMOS process. This unit operates from a single voltage supply and has internal temperature compensation of the bias voltage to ensure stable performance over the full temperature range. It is a drop-in, no-tune solution for medium power applications requiring high efficiency, excellent linearity, and unit-to-unit repeatability. It is internally matched to 50Ω.

Optimum Technology Matching® Applied

- GaAs HBT
- GaAs MESFET
- InGaP HBT
- SiGe BICMOS
- Si BiCMOS
- SiGe HBT
- GaAs pHEMT
- Si CMOS
- Si BJT
- GaN HEMT
- InP HBT
- RF MEMS
- LDMOS

Functional Block Diagram

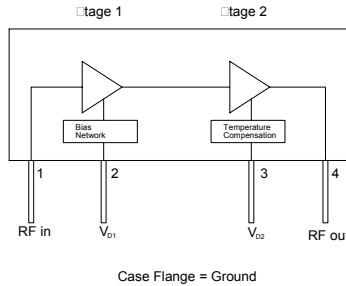

Features

- Available in RoHS Compliant Packaging
- 50Ω RF Impedance
- 15W output P_{1dB}
- Single Supply Operation: Nominally 28V
- High Gain: 32dB at 942MHz
- High Efficiency: 31% at 942MHz
- Robust 8000V ESD (HBM), Class 3B
- High Peak Power for Lower BER
- Ultra-Low EVM

Applications

- Base Station PA Driver
- Repeater
- GSM/EDGE

Parameter	Specification			Unit	Condition
	Min.	Typ.	Max.		
Frequency of Operation	925		960	MHz	
Output Power at 1dB Compression (Single Tone)	10	15		W	
Gain	30	32	35	dB	12W Output Power (CW)
Peak to Peak Gain Variation		0.4	1.0	dB	
Drain Efficiency	27	31		%	12W CW
Input Return Loss	12	18		dB	12W CW
RMS EVM		2.5		%	8W EDGE output
Peak EVM		6.7		%	8W EDGE output
Third Order IMD		-35	-30	dBc	12W PEP (Two Tone)
Deviation from Linear Phase (Peak to Peak)		0.5		Deg	
Thermal Resistance Stage 1 (Junction to Case)		11		°C/W	
Thermal Resistance Stage 2 (Junction to Case)		4		°C/W	

Test Conditions: Z_{IN} = Z_{OUT} = 50Ω V_{DD} = 28.0V I_{DQ1} = 230mA I_{DQ2} = 158mA T_{FLANGE} = 25 °C

Absolute Maximum Ratings

Parameter	Rating	Unit
1 st Stage Bias Voltage (V_{D1})	35	V
2 nd Stage Bias Voltage (V_{D2})	35	V
RF Input Power	+20	dBm
Load Impedance for Continuous Operation Without Damage	5:1	VSWR
Output Device Channel Temperature	+200	°C
Operating Temperature Range	-20 to +90	°C
Storage Temperature Range	-40 to +100	°C
ESD Rating - Human Body Model, JEDEC Document - JESD22-A114-B	8000	V
MTTF - 85°C Leadframe, 200°C Channel	1.2×10^6	Hours

Operation of this device beyond any one of these limits may cause permanent damage. For reliable continuous operation, the device voltage and current must not exceed the maximum operating values specified in the table on page one.



Caution! ESD sensitive device.

Exceeding any one or a combination of the Absolute Maximum Rating conditions may cause permanent damage to the device. Extended application of Absolute Maximum Rating conditions to the device may reduce device reliability. Specified typical performance or functional operation of the device under Absolute Maximum Rating conditions is not implied.

RoHS status based on EU Directive 2002/95/EC (at time of this document revision).

The information in this publication is believed to be accurate and reliable. However, no responsibility is assumed by RF Micro Devices, Inc. ("RFMD") for its use, nor for any infringement of patents, or other rights of third parties, resulting from its use. No license is granted by implication or otherwise under any patent or patent rights of RFMD. RFMD reserves the right to change component circuitry, recommended application circuitry and specifications at any time without prior notice.

Simplified Device Schematic

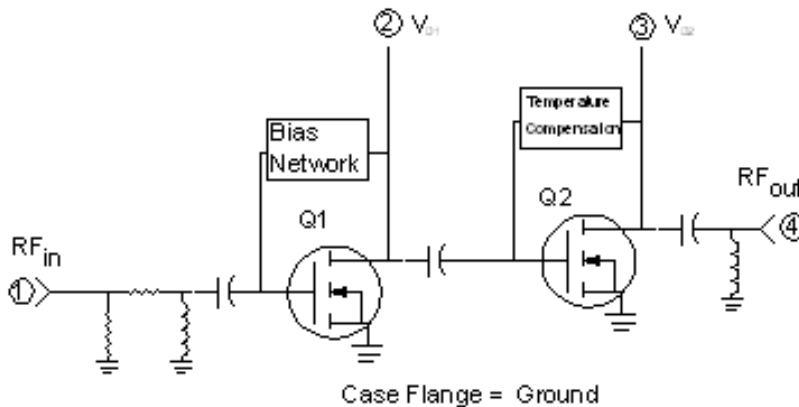

Typical Performance Curves

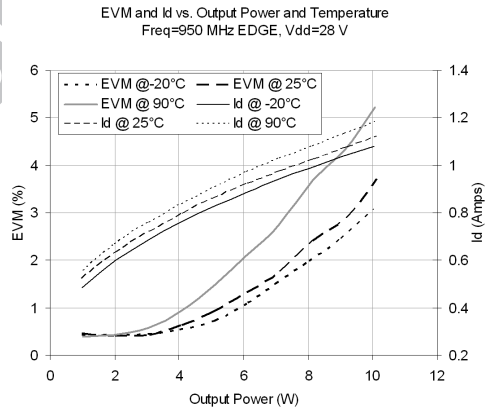
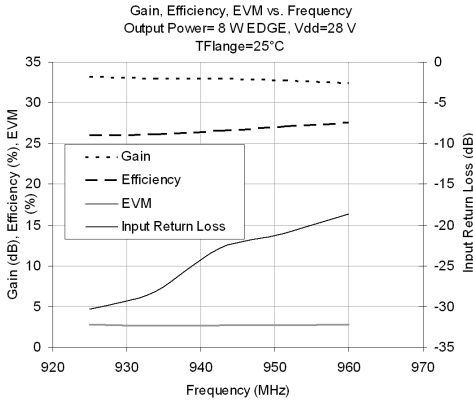
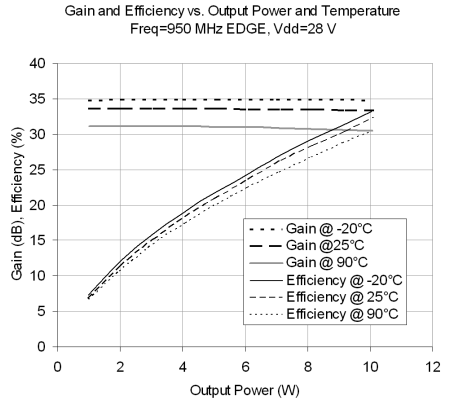
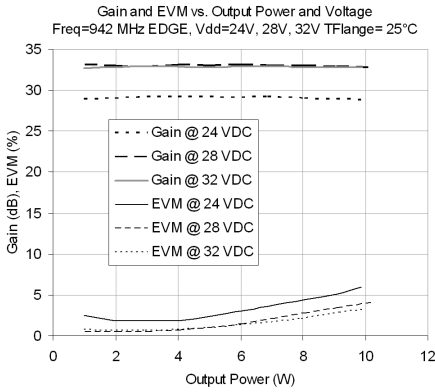

NOT A
W D

Pin	Function	Description
1	RFIN	Module RF input. This pin is internally connected to DC ground. Do not apply DC voltages to the RF leads. Care must be taken to protect against video transients that may damage the active devices.
2	VD1	This is the drain voltage for the first stage. Nominally +28Vdc
3	VD2	This is the drain voltage for the 2 nd stage of the amplifier module. The 2 nd stage gate bias is temperature compensated to maintain constant quiescent drain current over the operating temperature range. See Note 1.
4	RFOUT	Module RF output. This pin is internally connected to DC ground. Do not apply DC voltages to the RF leads. Care must be taken to protect against video transients that may damage the active devices.
Flange	GND	Exposed area on the bottom side of the package needs to be mechanically attached to the ground plane of the board for optimum thermal and RF performance. See mounting instructions in application note AN-060 on RFMD's web site.

Note 1: The internally generated gate voltage is thermally compensated to maintain constant quiescent current over the temperature range listed in the data sheet. No compensation is provided for gain changes with temperature. This can only be accomplished with AGC external to the module.

Note 2: Internal RF decoupling is included on all bias leads. No additional bypass elements are required, however some applications may require energy storage on the drain leads to accommodate time-varying waveforms.

Note 3: This module was designed to have its leads hand soldered to an adjacent PCB. The maximum soldering iron tip temperature should not exceed 700° F, and the soldering iron tip should not be in direct contact with the lead for longer than 10 seconds. Refer to app note AN060 (www.RFMD.com) for further installation instructions.

Test Board Layout

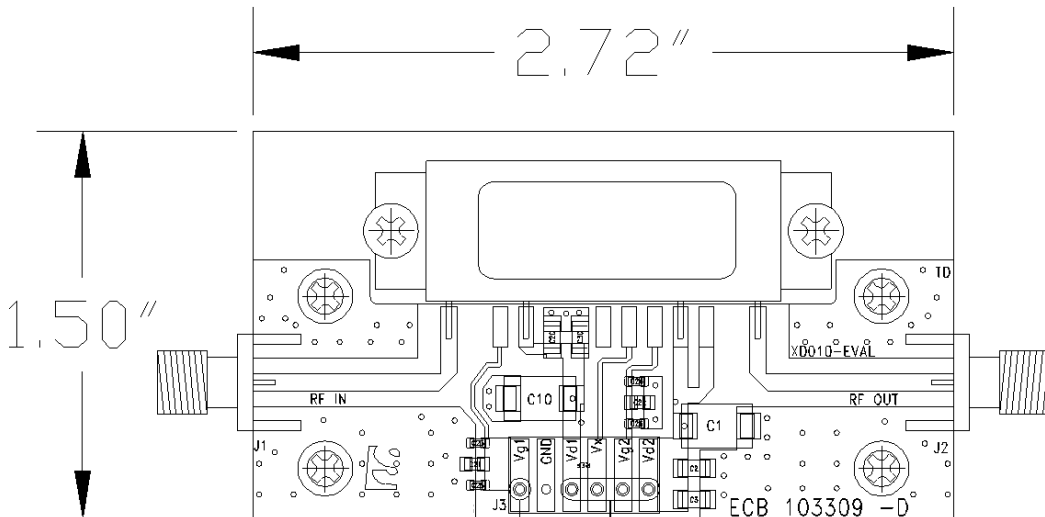

Test Board Schematic with module connections shown

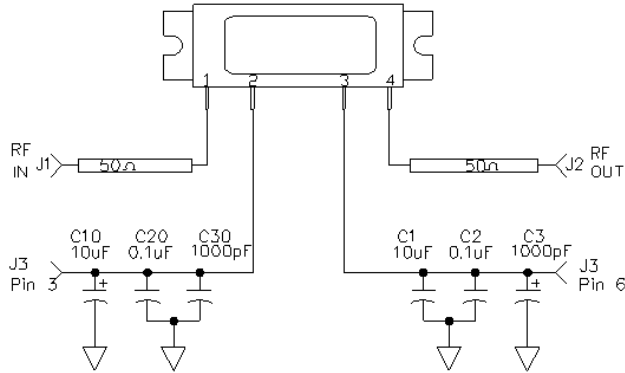

Test Board Bill of Materials

Component	Description	Manufacturer
PCB	Rogers 4350, $\epsilon_r=3.5$, Thickness=30mils	Rogers
J1, J2	SMA, RF, Panel Mount Tab W / Flange	Johnson
J3	MTA Post Header, 6 Pin, Rectangle, Polarized, Surface Mount	AMP
C1, C10	Cap, 10 μ F, 35V, 10%, Tant, Elect, D	Kemet
C2, C20	Cap, 0.1 μ F, 100V, 10%, 1206	Johanson
C3, C30	Cap, 1000pF, 100V, 10%, 1206	Johanson
C25, C26	Cap, 68pF, 250V, 5%, 0603	ATC
C21, C22	Cap, 0.1mF, 100V, 10%, 0805	Panasonic
C23, C24	Cap, 1000pF, 100V, 10%, 0603	AVX
Mounting Screws	4-40 X 0.250"	Various

NOT FOR MOUNTING

Package Outline Drawing

Dimensions in inches (millimeters)

Refer to drawing posted at www.rfmd.com for tolerances.

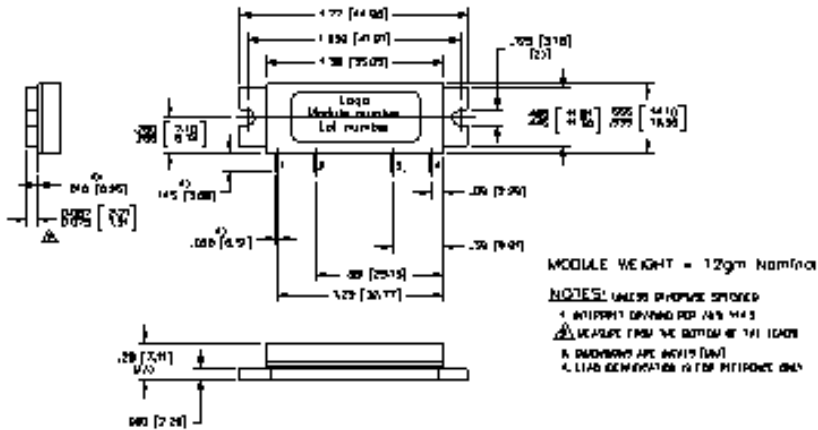

Recommended PCB Cutout and Landing Pads for the D4F Package

Dimensions in inches (millimeters)

