

PART NUMBER	SML-LXIL2324UPGC-TR	REV.	B
DATE	E.C.N. NUMBER AND REVISION COMMENTS		REV.
10.03.13	E.C.N. #10BRDR. & REDRAWN.		A
10.03.13	E.C.N. #11880.		B

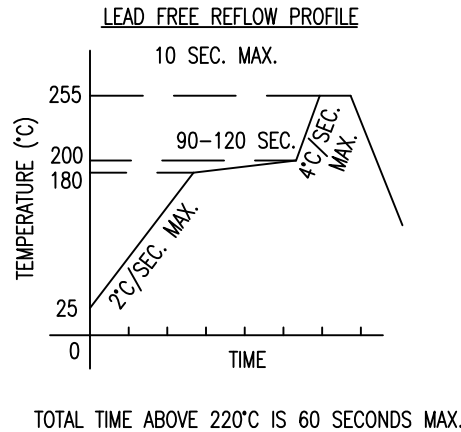

ELECTRO-OPTICAL CHARACTERISTICS $T_A=25^\circ\text{C}$ $I_f=20\text{mA}$

PARAMETER	SYMBOL	MIN	TYP	MAX	UNITS	TEST COND
PEAK WAVELENGTH			528		nm	
FORWARD VOLTAGE	V_f		3.0	3.5	V	$I_f=20\text{mA}$
REVERSE VOLTAGE	V_r			5	V	$I_r=10\mu\text{A}$
AXIAL INTENSITY	I_v		50000		mcd	$I_f=20\text{mA}$
VIEWING ANGLE			8		deg	
EMITTED COLOR:	GREEN					
EPOXY LENS FINISH:	WATER CLEAR					

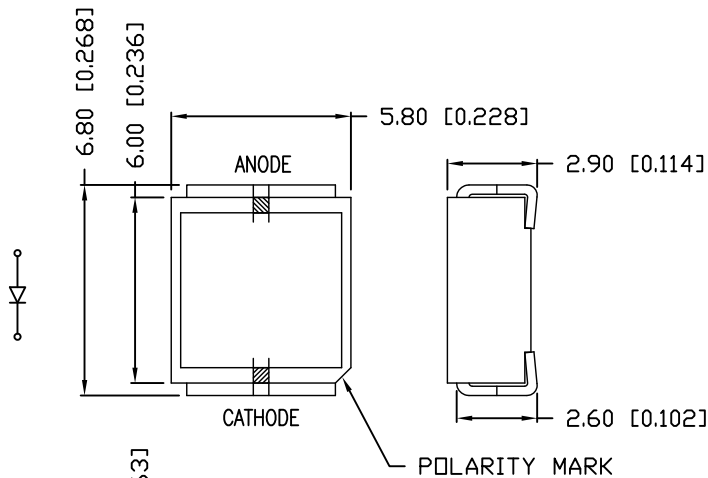
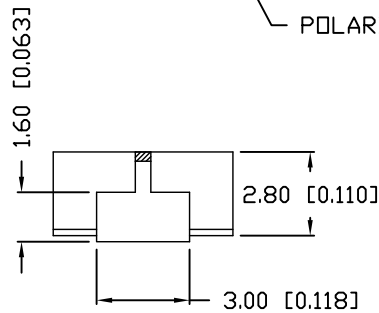

PAD LAYOUT

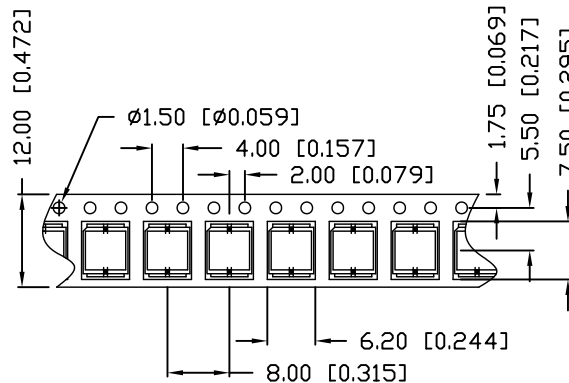
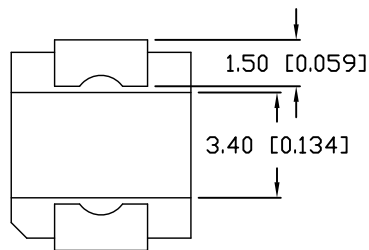
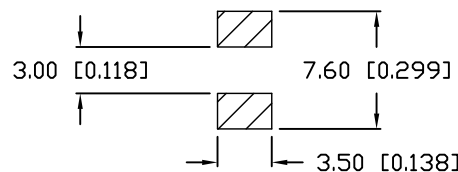

LIMITS OF SAFE OPERATION AT 25°C

PARAMETER	SYMBOL	MAX	UNITS
STEADY CURRENT	I_F	30	mA
POWER DISSIPATION	P_D	120	mW
OPERATING TEMP.	T_{OPR}	-30 TO +85	°C
STORAGE TEMP.	T_{STG}	-30 TO +90	°C

NOTES:

CATHODE IS ORIENTED TOWARDS THE TAPE SPOCKET HOLE.

CAUTION: MOISTURE SENSITIVE DEVICE
PER JEDEC LEVEL 4 STANDARDS

*UNLESS OTHERWISE SPECIFIED TOLERANCES PER DECIMAL PRECISION ARE: X=±1 (±0.039), X.X=±0.5 (±0.020), X.XX=±0.25 (±0.010), X.XXX=±0.127 (±0.005). LEAD SIZE=±0.05 (±0.002), LEAD LENGTH=±0.75 (±0.030). MIN.=^{+DECIMAL PRECISION}_{-0.00} MAX.=^{+0.00}_{-DECIMAL PRECISION}



425 N. GARY AVE.
CAROL STREAM, IL 60188-4900
PHONE: +1.800.278.5666
FAX: +1.630.315.2152
WEB: WWW.LUMEX.COM
MEMBER OF ITW PHOTONICS GROUP

NARROW BEAM 6mm SMT LED, 528nm GREEN LED, WATER CLEAR LENS.

THE SPECIFICATIONS MAY CHANGE AT ANY TIME WITHOUT NOTICE DUE TO NEW MATERIALS OR PRODUCT IMPROVEMENT.

CONFIDENTIAL INFORMATION
THE INFORMATION CONTAINED IN THIS DOCUMENT IS THE PROPERTY OF LUMEX INC. EXCEPT AS SPECIFICALLY AUTHORIZED IN WRITING BY LUMEX INC., THE HOLDER OF THIS DOCUMENT SHALL KEEP ALL INFORMATION CONTAINED HEREIN CONFIDENTIAL AND SHALL PROTECT SAME IN WHOLE OR IN PART FROM DISCLOSURE AND DISSEMINATION TO ALL THIRD PARTIES.

DATE:	10.03.13	DRAWN BY:	MA
PAGE:	1 OF 2	CHKD BY:	RU
SCALE:	NTS	APRVD BY:	RU
UNIT:	mm [INCH]		(Pb)

PART NUMBER	SML-LXIL2324UPGC-TR	REV.	B
DATE	E.C.N. NUMBER AND REVISION COMMENTS		REV.
10.03.13	E.C.N. #10BRDR. & REDRAWN.		A
10.03.13	E.C.N. #11880.		B

A

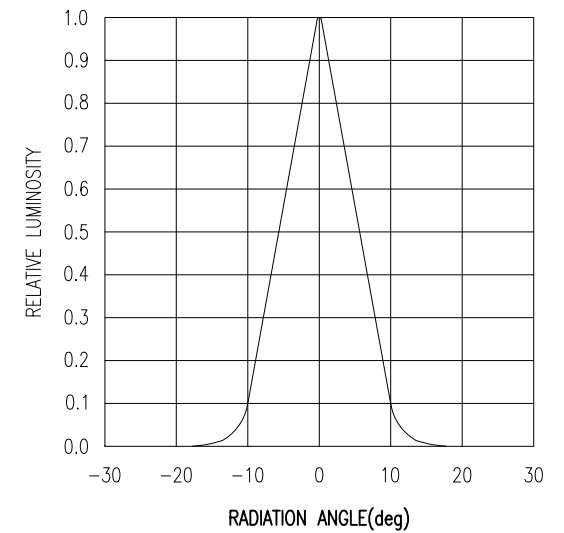
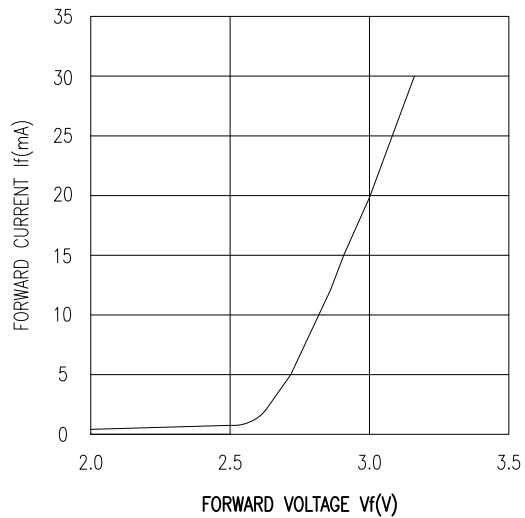
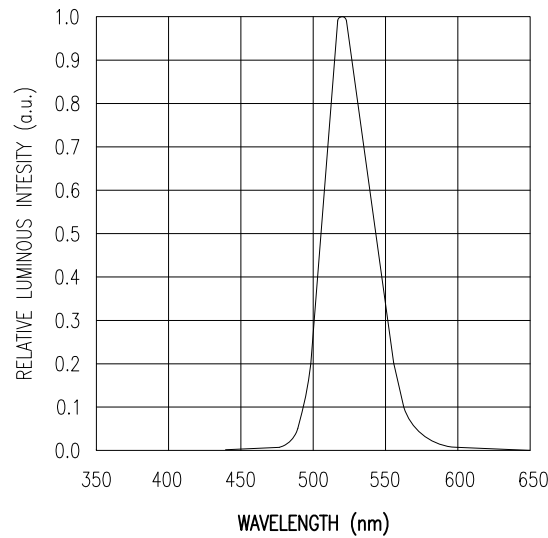
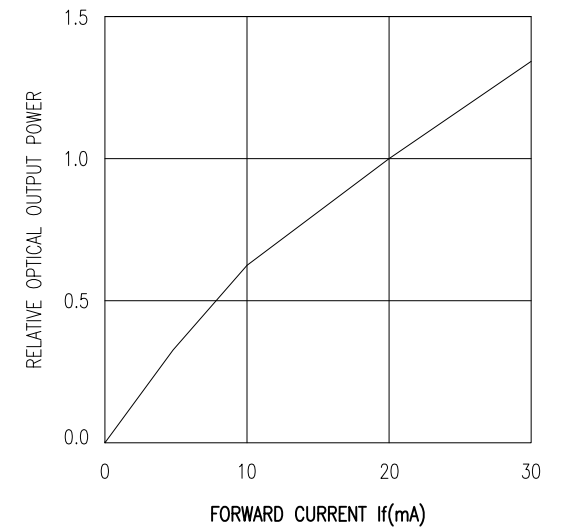
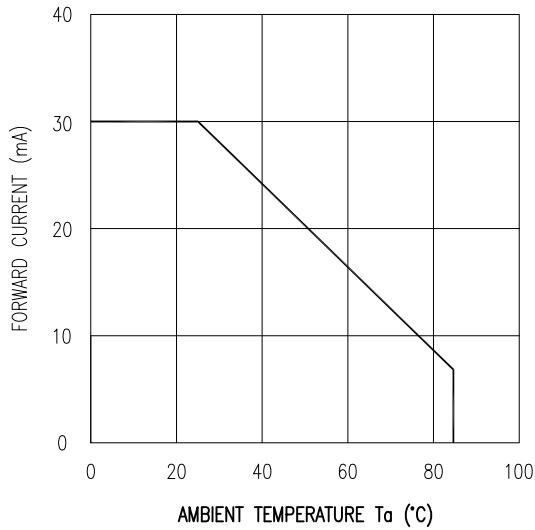

*UNLESS OTHERWISE SPECIFIED TOLERANCES PER DECIMAL PRECISION ARE: X=±1 (±0.039), X.X=±0.5 (±0.020), X.XX=±0.25 (±0.010), X.XXX=±0.127 (±0.005). LEAD SIZE=±0.05 (±0.002), LEAD LENGTH=±0.75 (±0.030). MIN.=^{+DECIMAL PRECISION}-0.00 MAX.=^{+0.00}-DECIMAL PRECISION UNCONTROLLED DOCUMENT

LUMEX
 Creating LED and LCD Solutions Together™
 425 N. GARY AVE.
 CAROL STREAM, IL 60188-4900
 PHONE: +1.800.278.5666
 FAX: +1.630.315.2152
 WEB: WWW.LUMEX.COM
 MEMBER OF ITW PHOTONICS GROUP

NARROW BEAM 6mm SMT LED, 528nm GREEN LED, WATER CLEAR LENS.
 THE SPECIFICATIONS MAY CHANGE AT ANY TIME WITHOUT NOTICE DUE TO NEW MATERIALS OR PRODUCT IMPROVEMENT.
 CONFIDENTIAL INFORMATION
 THE INFORMATION CONTAINED IN THIS DOCUMENT IS THE PROPERTY OF LUMEX INC. EXCEPT AS SPECIFICALLY AUTHORIZED IN WRITING BY LUMEX INC., THE HOLDER OF THIS DOCUMENT SHALL KEEP ALL INFORMATION CONTAINED HEREIN CONFIDENTIAL AND SHALL PROTECT SAME IN WHOLE OR IN PART FROM DISCLOSURE AND DISSEMINATION TO ALL THIRD PARTIES.

DATE: 10.03.13	DRAWN BY: MA
PAGE: 2 OF 2	CHKD BY: RU
SCALE: NTS	APRVD BY: RU
UNIT: mm [INCH]	Ⓟ